

THE PROPERTY OF THE DRAWING IS ESTABLISHED BY LAW. IT IS FORBIDDEN TO PRODUCE OR SHOW IT TO THIRD PART. WITHOUT A WRITTEN AGREEMENT.

Item	Name	Q.ty
1	CA.08.09.014	1
2	CA.08.28.004	1

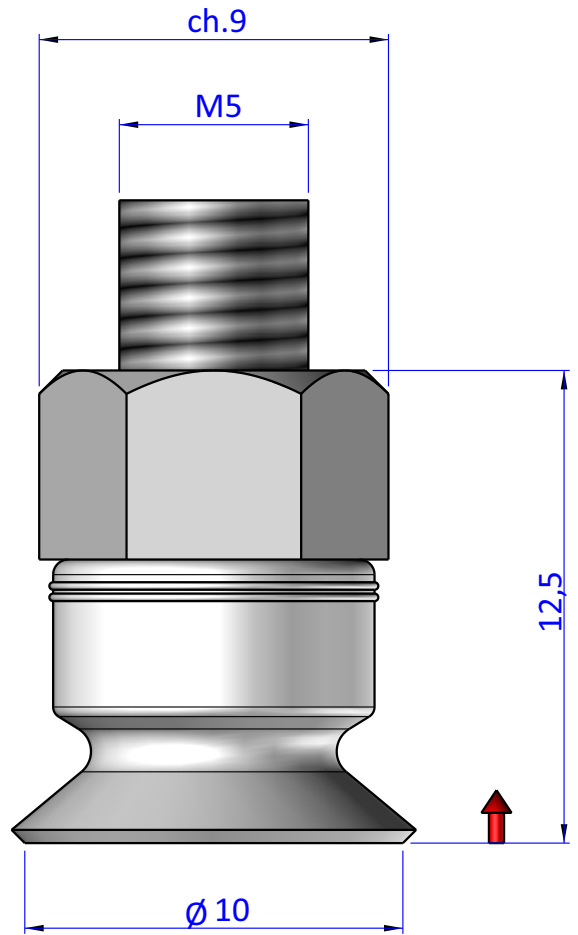
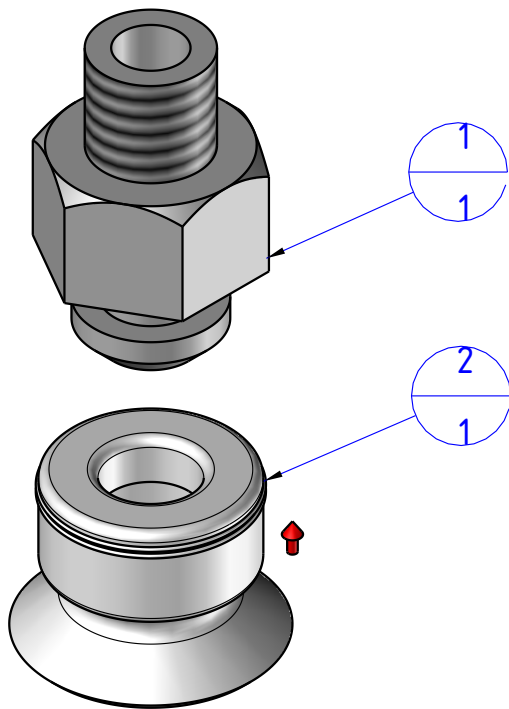

DESIGNED FROM FPS Automation	REVIEW A
--	--------------------

DATE 18/11/2020	WEIGHT 0,001kg
---------------------------	--------------------------

CODE KIT.08.28.D10

Format **A4**

UNI 936-76

GENERAL TOLERANCE

UNI - ISO 2768

CLASSE f

DESCRIPTION

KIT.08.28.D10